

Schnitt B-B  
Section B-B

Ansicht "Z"  
View "Z"

Platine Oberteil  
P C B Top Part

Platine Unterteil  
P C B Bottom Part

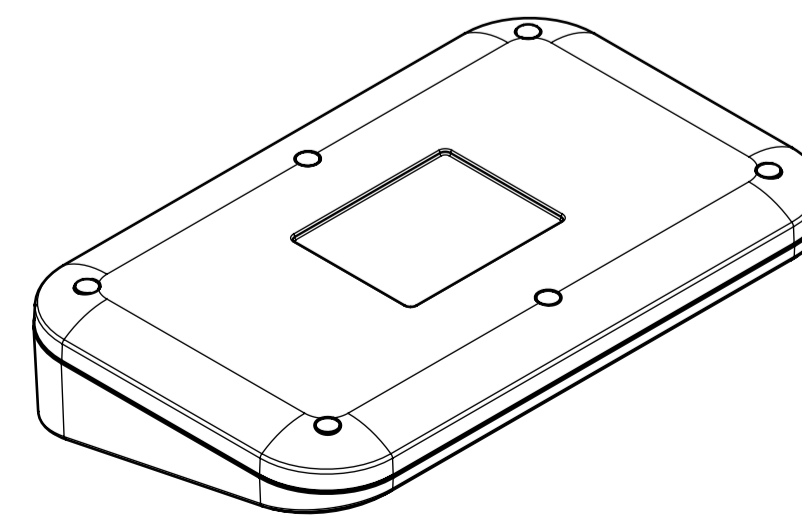
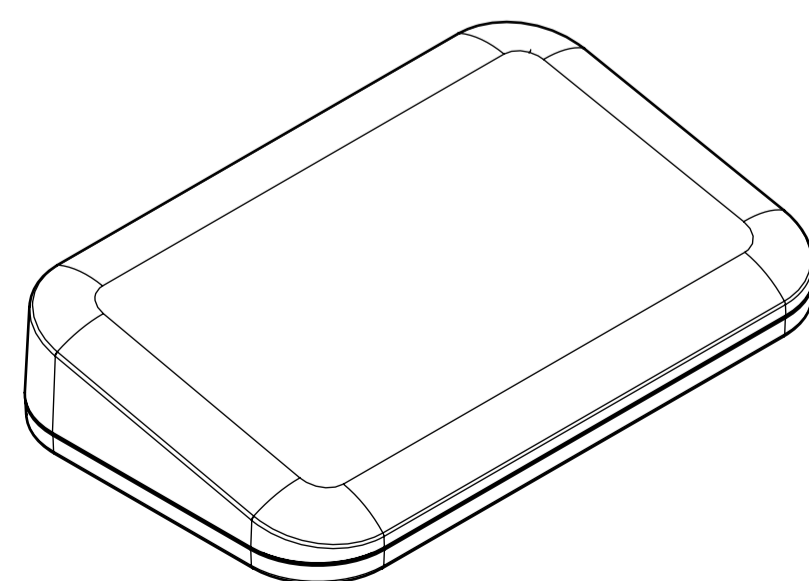
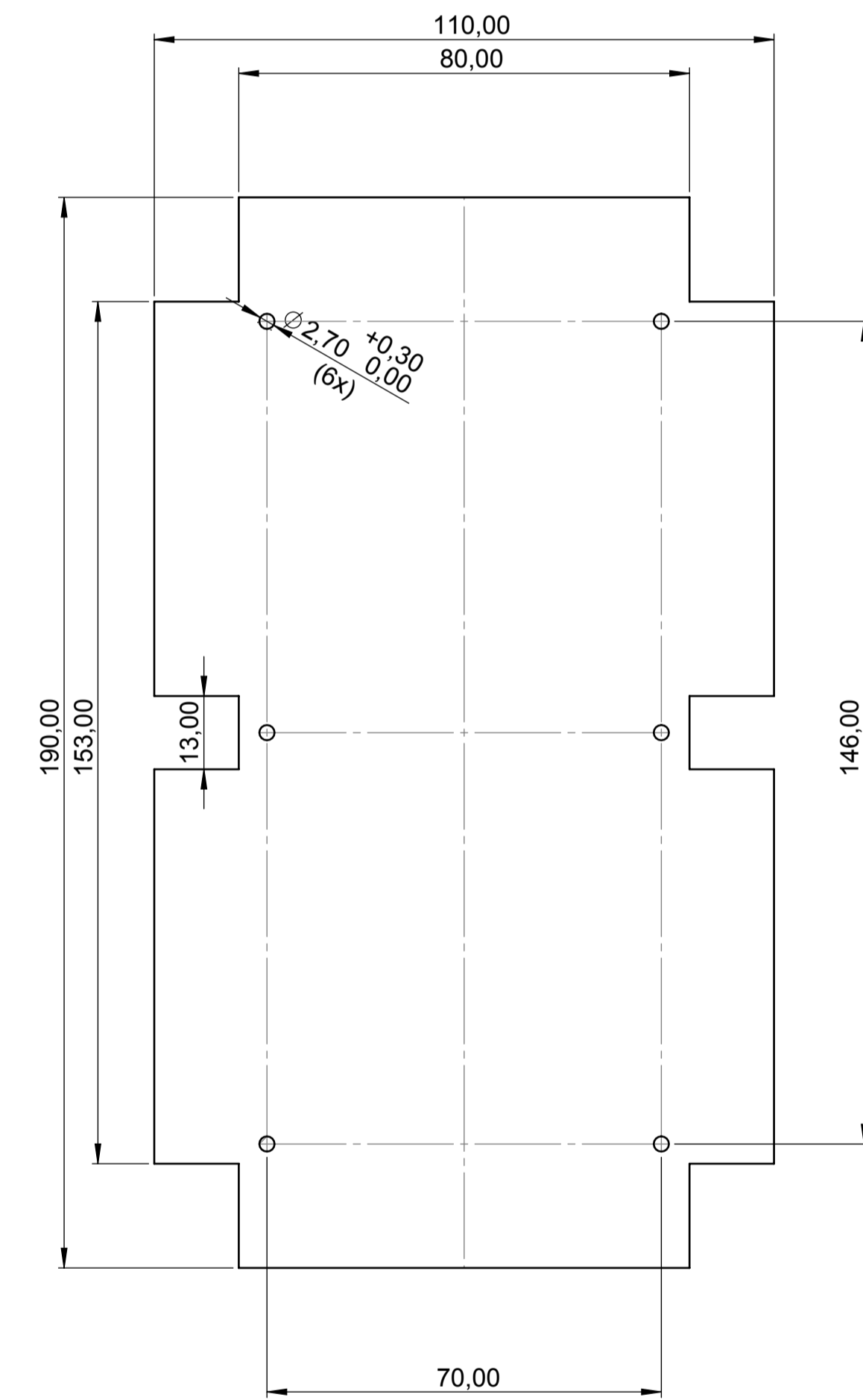
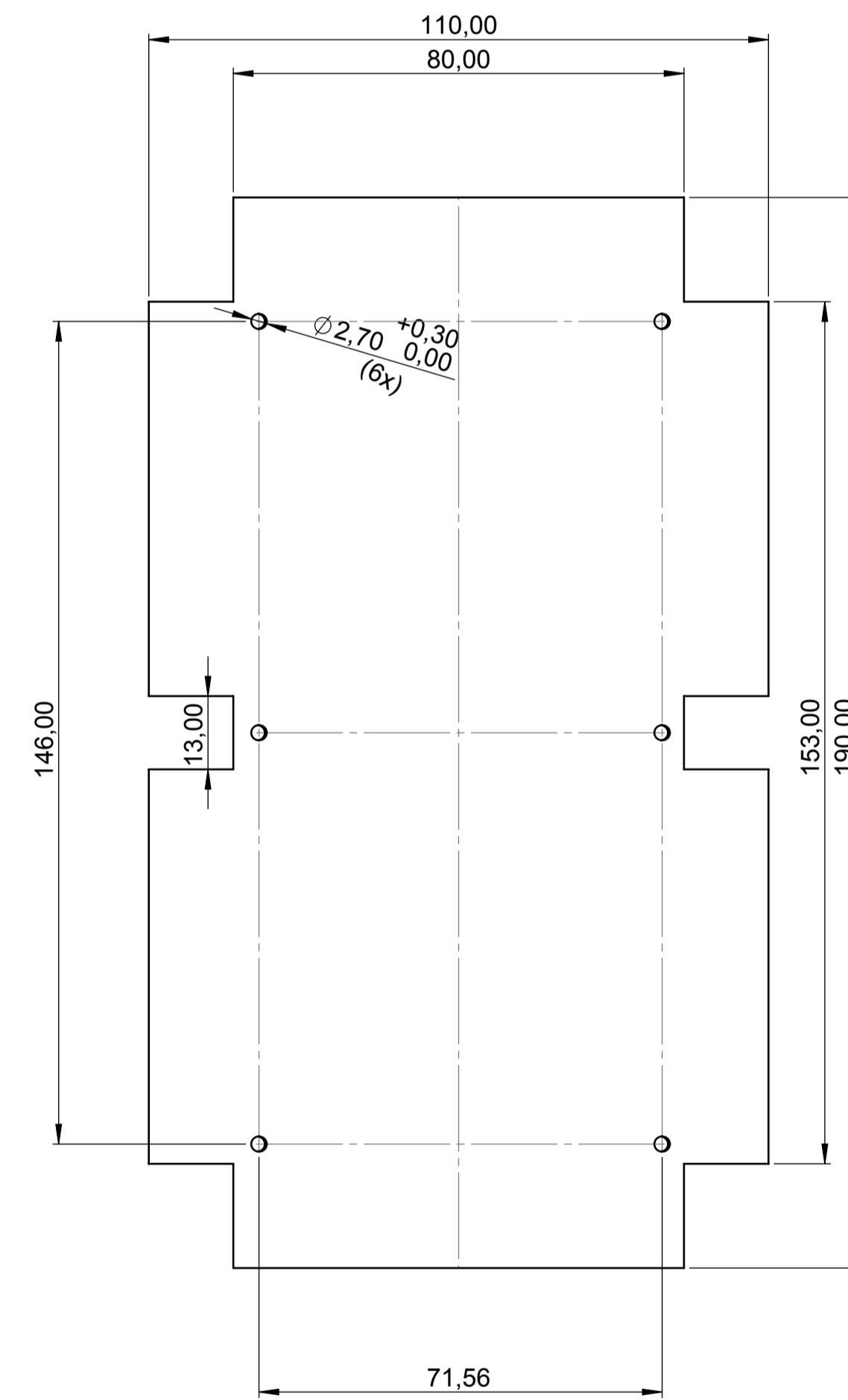
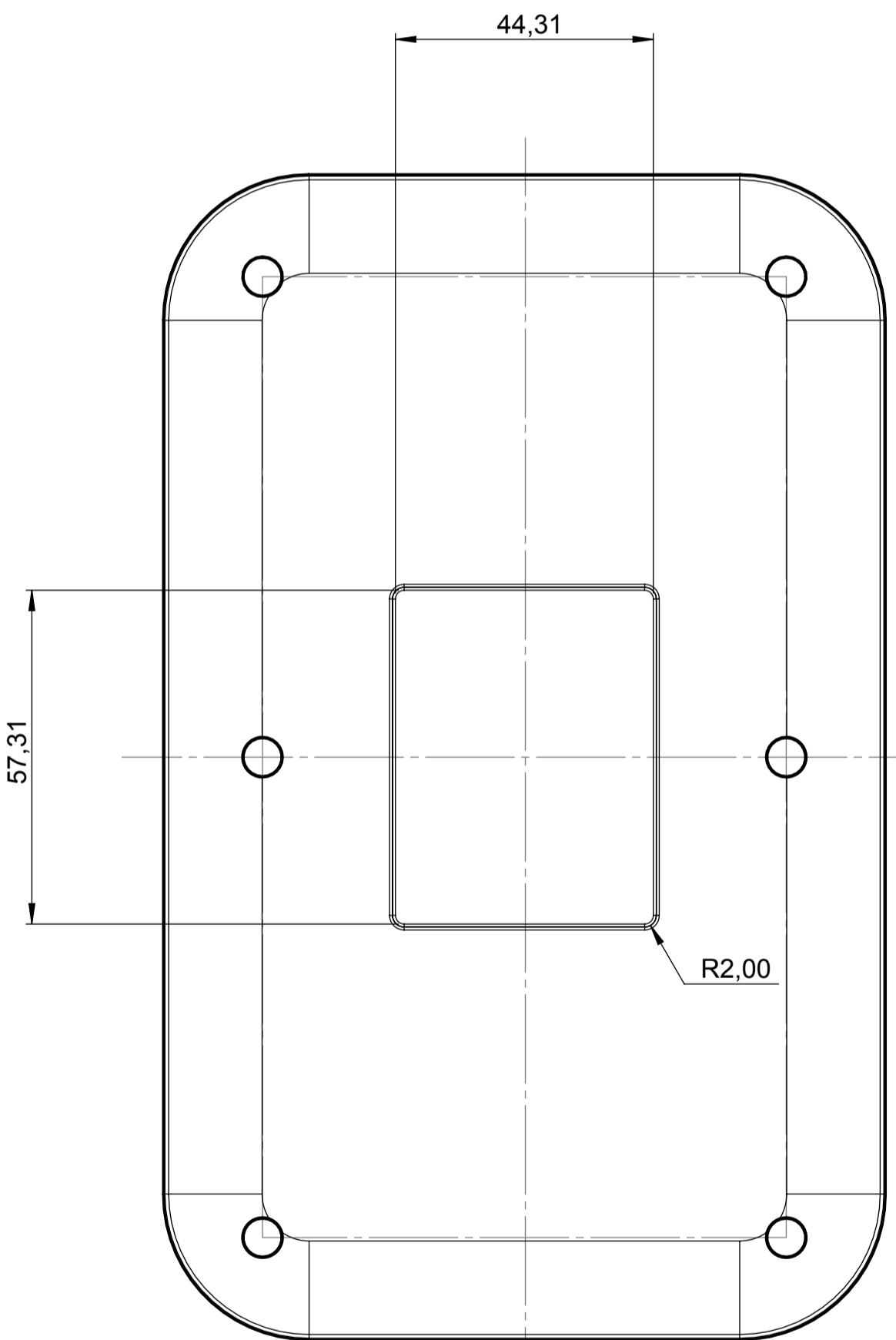
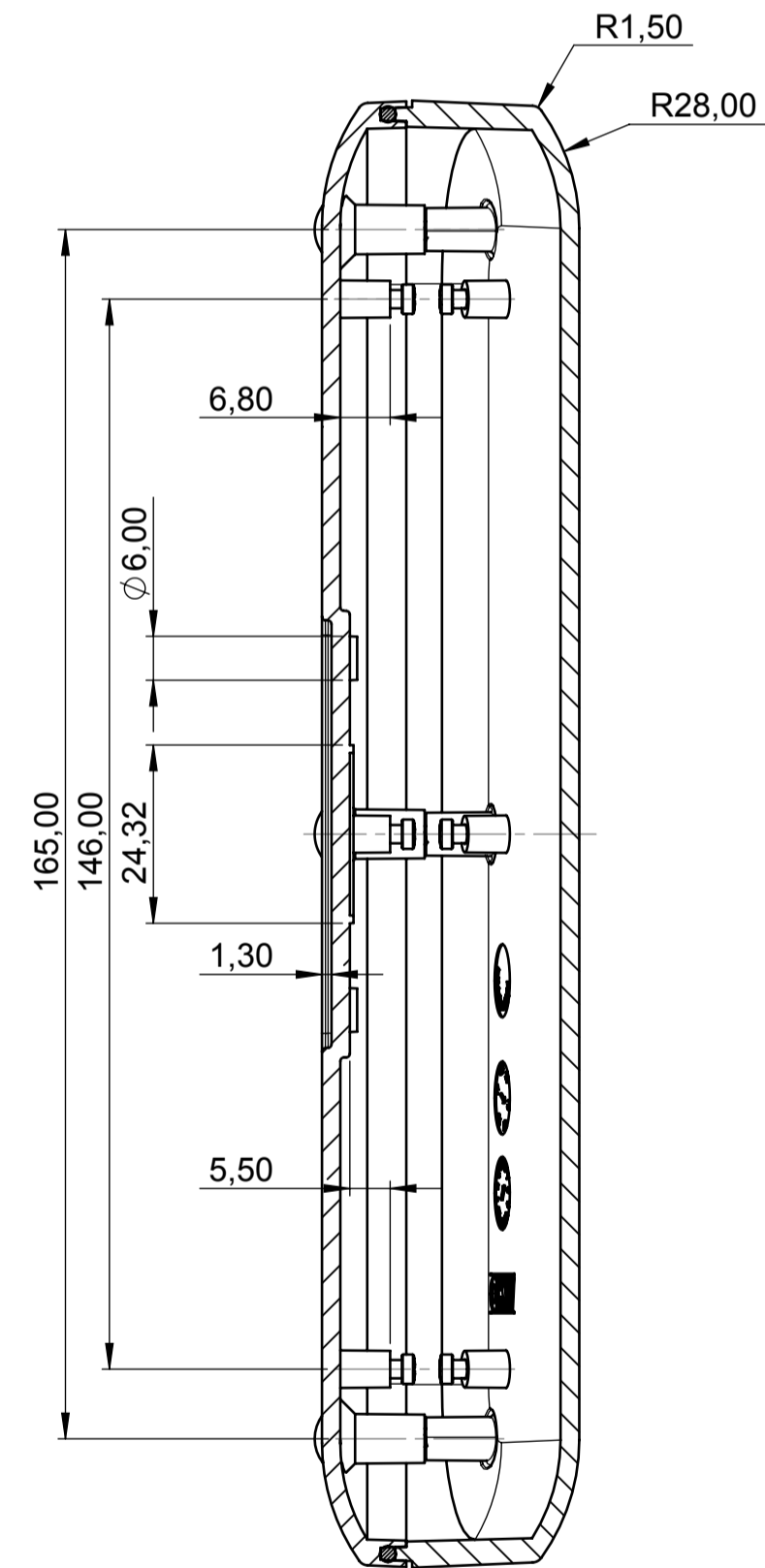
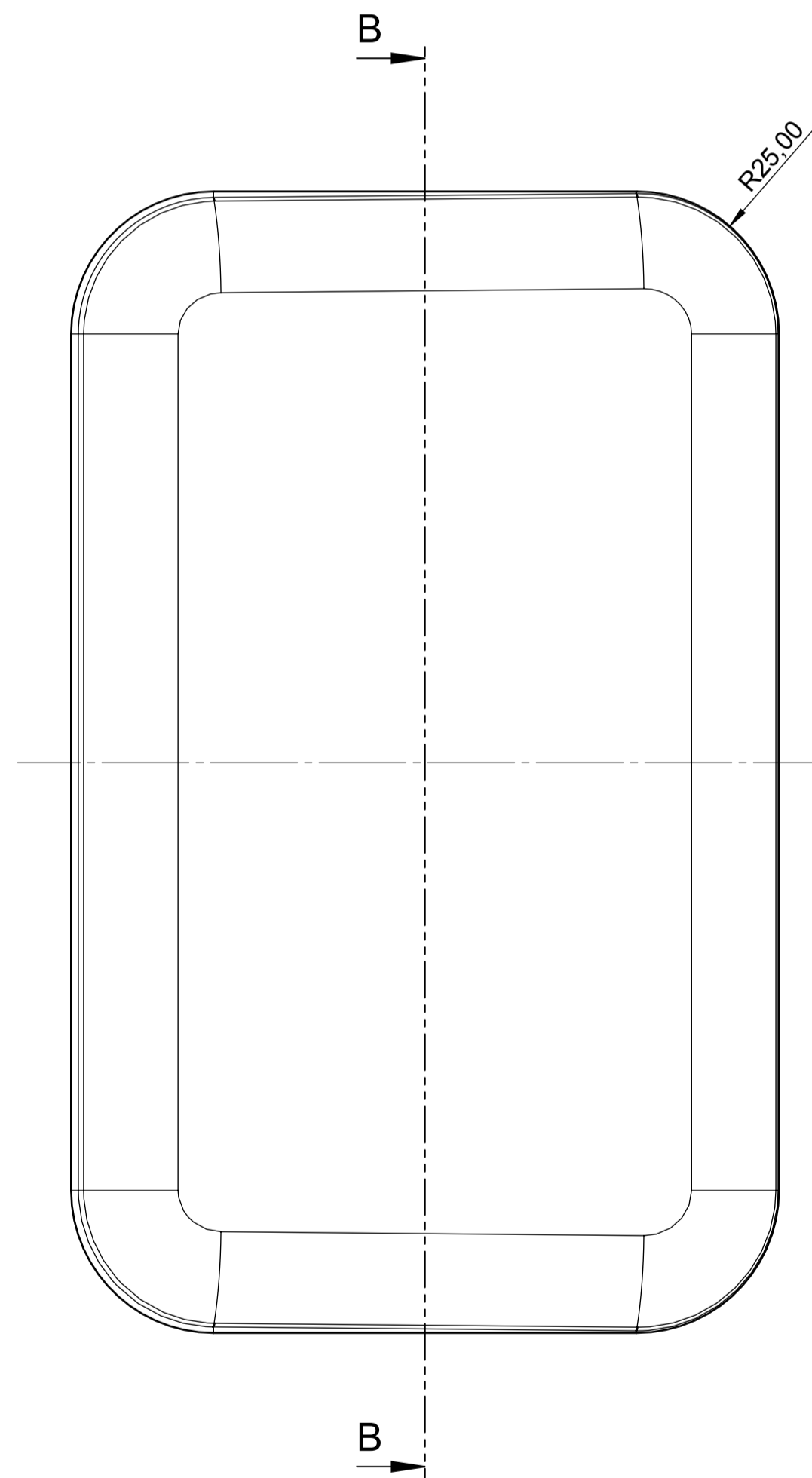

<b>Informationskopie</b> wird nicht aktualisiert <b>Copy for Information</b> will not be updated	Erst. am: 04.08.2016 Erst. von: O. Herrlich Freig. am: Freig. von: Revision: 01	Toleranzen: DIN 16901 T130 Volumen: Zeichnungsart: KUNDE	Status: ENTWICKLUNG Zeichnungsart: KUNDE DIN 6 Teil 2
	This document contains proprietary information of OKW Gehäusesysteme GmbH and is rendered subject to the conditions that the information be retained in confidence and is not to be reproduced or copied and not be used or incorporated in any product.		
	<b>OKW</b> <b>GEHÄUSE</b> <b>SYSTEME</b>		
	<b>EVOTEC 200</b> <b>Ausf. II (Oberteil pult ohne Vertiefung)</b> <b>A9465100</b> M 1:1 Für dieses Dokument behalten wir uns alle Urheberrechte vor. Es darf auch auszugsweise weder vervielfältigt noch Dritten in irgendeiner Form zugänglich gemacht werden.		