

変更 REVISIONS			
回数 REV. MARK	日付 DATE	記事 CONTENTS	変更者 REVISED BY

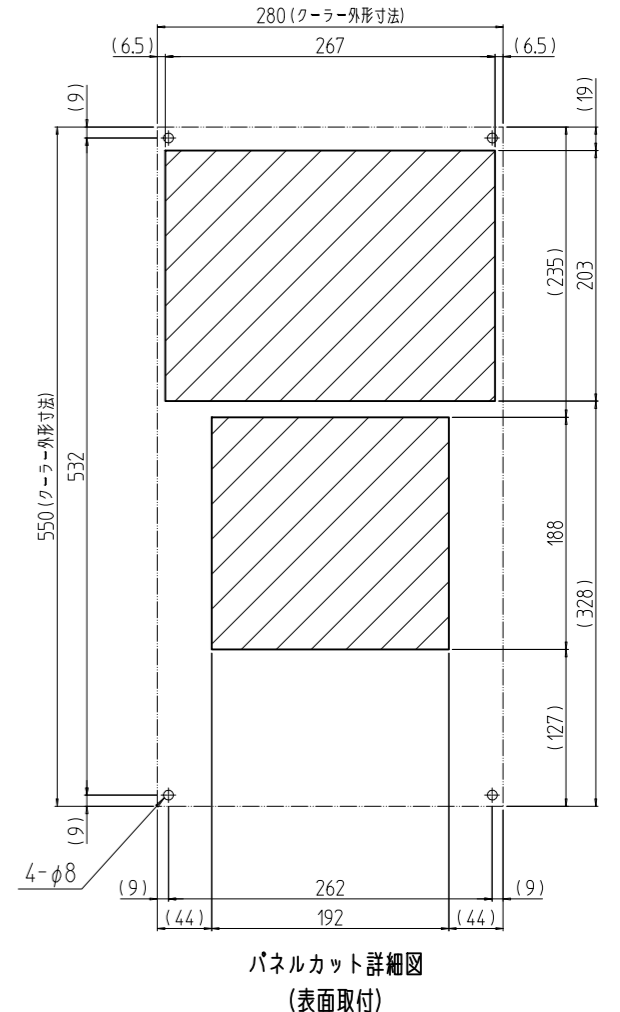
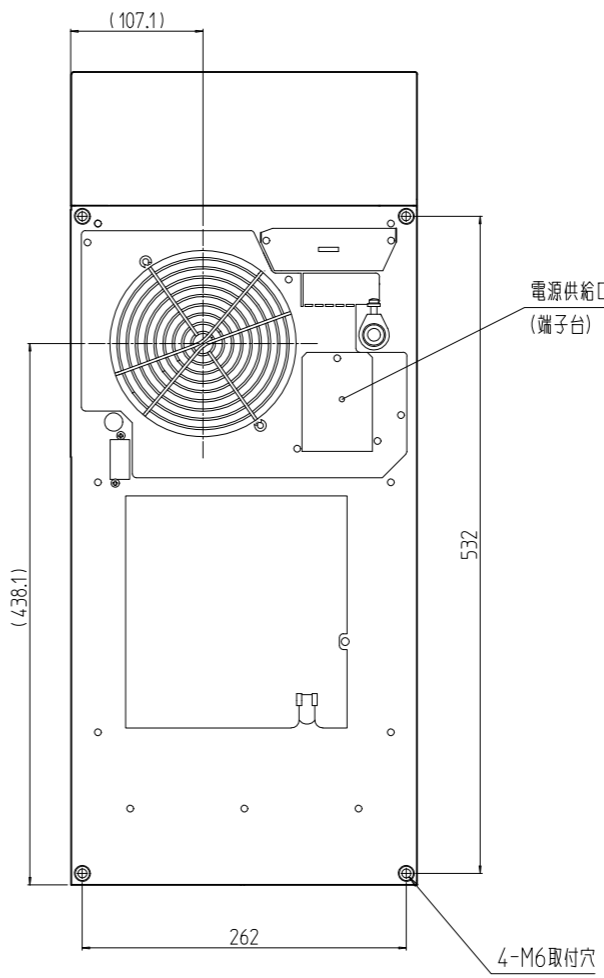
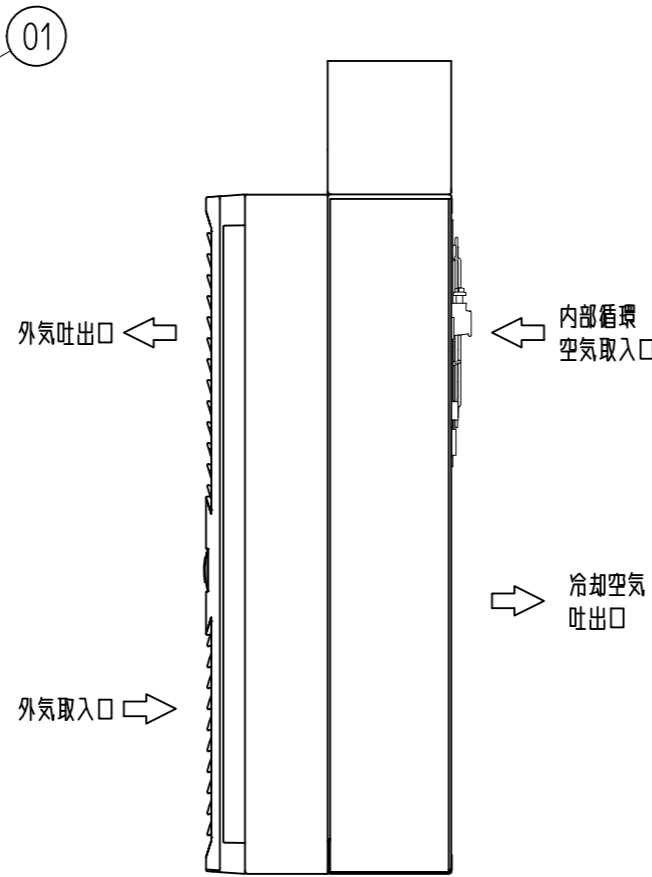
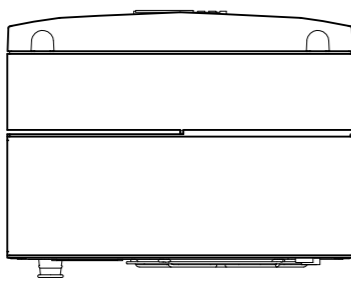
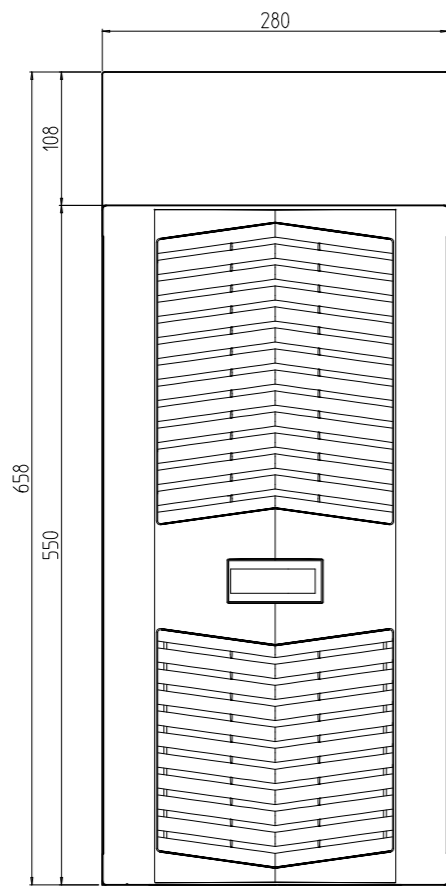
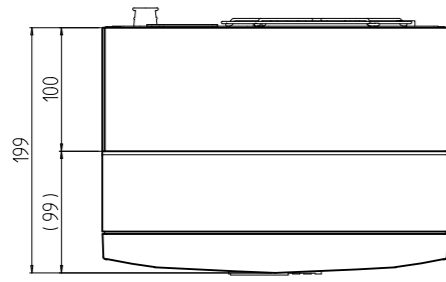

1	01	クーラー(200V500W)	塗装鋼板 等	ライトグレー
個数 QUANTITY	No.	図番 DRAWING No.	部品名 PART NAME	材質 MATERIAL
				仕上 FINISH
		単位 UNIT	設計 DESIGNED	図名 TITLE
		mm	検図 CHECKED	
			承認 APPROVED	
				品名 NAME
				型式 MODEL
				図番 DRAWING No.

SETTSU 摂津金属工業株式会社

SCN-021011