

Series 19 PCB Tainer

WEIGHT

0.63 g/cm (.056 oz./in.)

MATERIALS AND FINISH

Material:

.010-in. (.25-mm)
Beryllium Copper per
ASTM B-194 or Stainless
Steel per Mil-S-5059

Finish:

See finish table on
opposite page

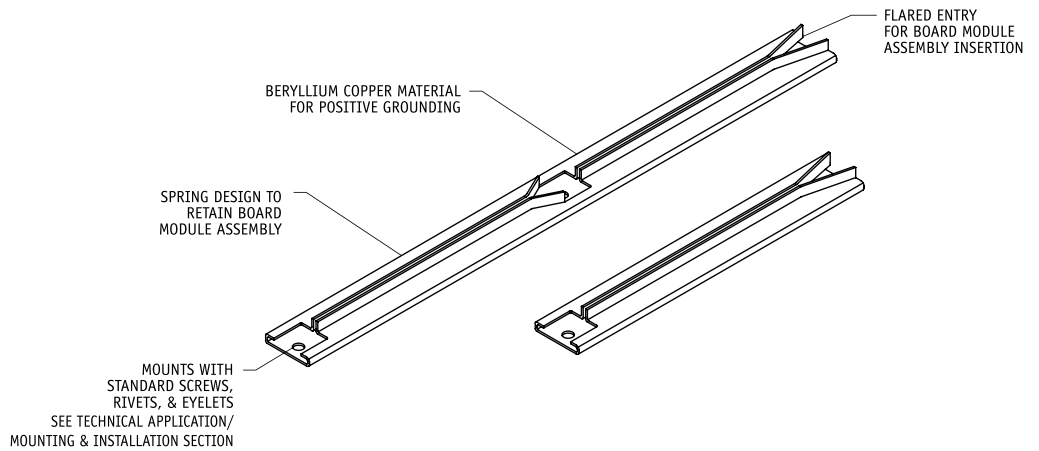

DIMENSION TABLE

SERIES #	A BOARD THICKNESS	B	C	D BERYLLIUM COPPER +.25\-.51 (+.010\-.020)	D STAINLESS STEEL .51 (.020)	F MOUNTING HOLE +.03\-.08 (.001\-.003)
19	3.18 (.125)	2.54 (.100)	5.47 (.215)	6.35 (.250)	6.35 (.250)	2.77 (.109)

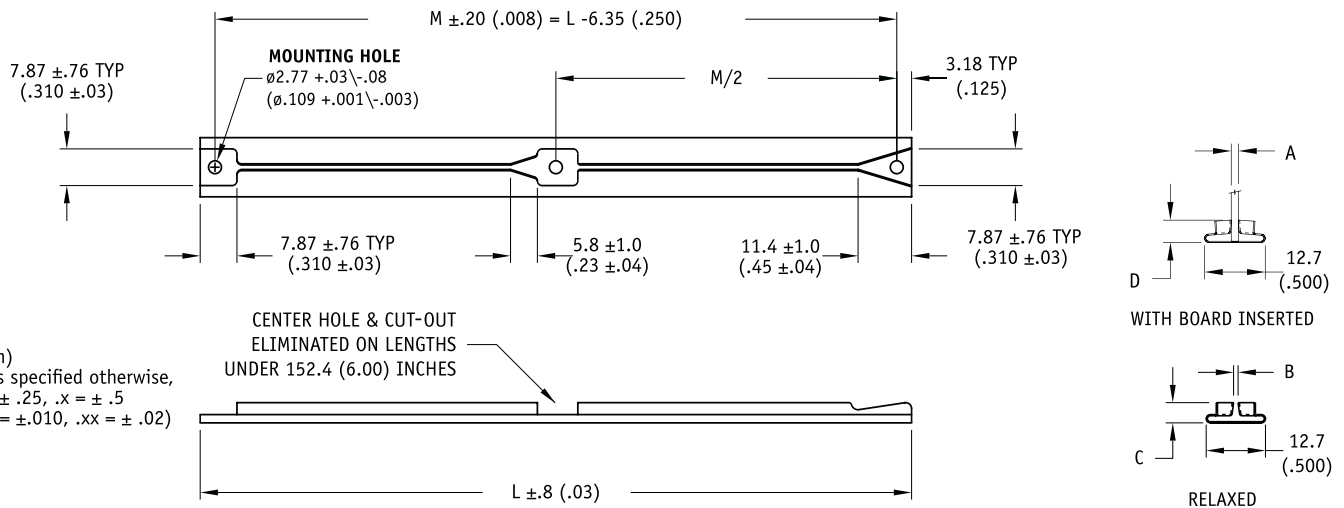

Units: mm(in)
unless specified otherwise,
.xx = ± .25, .x = ± .5
(.xxx = ±.010, .xx = ± .02)

MATERIALS TABLE

CODE LETTER	MATERIAL
B	BERYLLIUM COPPER, 1/4H PER ASTM-B-194
BH	BERYLLIUM COPPER, 1/4HT PER QQ-C-533, HEAT TREATED
CR	STAINLESS STEEL, TYPE 301 COND 1/4 H PER AMS 5517

FINISH TABLE

DASH #	
[blank]	SILVER PLATE PER QQ-S-365, TYPE III, GRADE A
-1	NONE
-3	CADMIUM PER QQ-P-416, TYPE 2, CLASS 2
-4	COPPER PLATE PER MIL-C-14550, CLASS 2
-5	GOLD PLATE PER MIL-G-45204, TYPE 1, GLASS 1
-6	NICKEL PLATE PER QQ-N-290, CLASS 1, GRADE G, BRIGHT
-7	ZINC PLATE CLEAR CHROMATE, PER ASTM-B-633, Fe/Zn 8
-8	ZINC PLATE YELLOW CHROMATE, PER ASTM-B-633, Fe/Zn 8

Part Number Code

Series 19 PCB-TAINER

ZB- 19 B - 10 - 5

Material

Beryllium Copper _____ B

or select from Materials Table

Length

Length in 12.7 (.50) increments _____ 4 [50.8 (2.00)]
 _____ to 20 [254.0 (10.00)]

Finish

Gold Plate _____ 5

or select from Finish Table

No dash number required for CR material. Stainless steel parts are passivated only.

Part Number Code example: 19B-18-6

19 Series PCB-TAINER, Beryllium Copper, for 1.59-mm (.063-in.) thick board, 228.7-mm (9.00-in.) long, Nickel Plate finish.